



AÑOS
DE GARANTÍA

LM
80



CINOR 11W

Tracklight con driver dimerizable para embutir en riel.
Cuerpo de aluminio. Antideslumbrante color negro incluido

💡 740 lm

⚡ 11W 220V

☼ CRI >90

📉 PF 0.9

🌓 Dim

📐 20° / 27° / 36°

🌡️ 2700K / 3000K / 4000K

🎨 Acabado: negro/blanco

CINOR 11W

ESPECIFICACIONES TÉCNICAS

| Código | CT | Dim. | Sist. dim | Áng. | CRI | lm | lm/W | W | V | IP |
|--------|-------|------|-----------|-------------|-----|-----|------|----|-----|----|
| TL45 | 2700K | Sí | TRIAC | 20°/27°/36° | >90 | 705 | 70 | 11 | 220 | 20 |
| TL45 | 3000K | Sí | TRIAC | 20°/27°/36° | >90 | 740 | 65 | 11 | 220 | 20 |
| TL45 | 4000K | Sí | TRIAC | 20°/27°/36° | >90 | 820 | 75 | 11 | 220 | 20 |

MacAdam <5

DISTRIBUCIÓN DE INTESIDAD LUMÍNICA

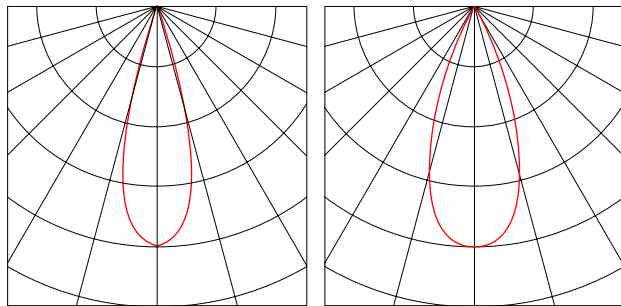

$I_{max}=4244$ cd
 α C0-C180 =20°

$I_{max}=2900$ cd
 α C0-C180 =27°

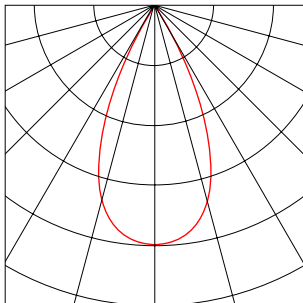

Parámetros
de fotometría en 3000K

$I_{max}=1552$ cd
 α C0-C180 =36°

PROYECCIÓN DE LUZ A DISTANCIA

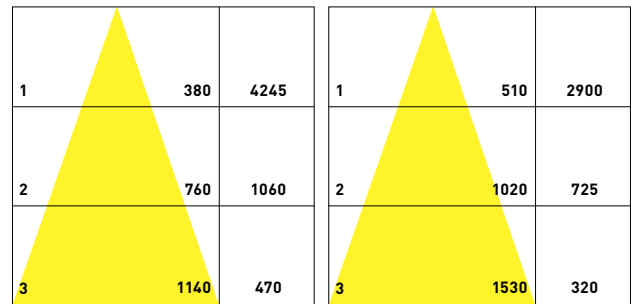

M (Altura) 20° (Diámetro) lx

M (Altura) 27° (Diámetro) lx

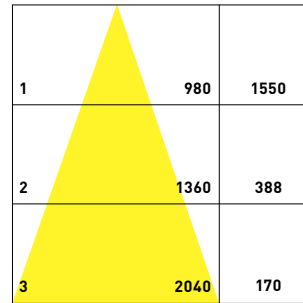

M (Altura) 36° (Diámetro) lx

DIMENSIONES SPOT 11W

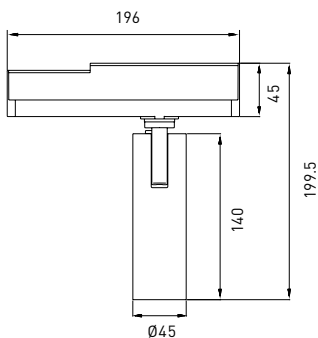

Driver y adaptador incluidos.
Opción driver DALI disponible.



CINOR 11W

RIELES COMPATIBLES

Riel 3 efectos marca Artelum modelos: 53411, 53412 y 53413

Riel 3 efectos marca Starnova modelos "Euro"

ACCESORIOS OPCIONALES

| Código | Descripción |
|-------------|---|
| TL-20W-DPOT | Driver lineal para armado de Cinor en perfil de 20W. Válido para 2 Cinor 11W o 1 Cinor 20W. |
| TL-30W-DPOT | Driver lineal para armado de Cinor en perfil de 30W. Compatible únicamente con Cinor 27W. |

CONFIGURABLE

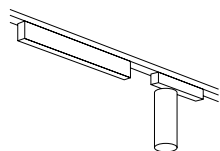

Los artefactos de la línea Cinor son configurables con perfiles Linear, Linear Slim y Slim Box.

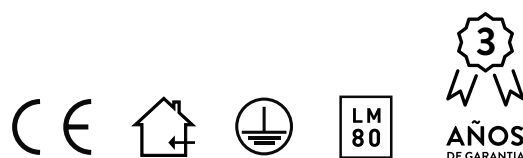



AÑOS
DE GARANTÍA

LM
80



CINOR 20W

Tracklight con driver dimerizable para embutir en riel.
Cuerpo de aluminio. Antideslumbrante color negro incluido

💡 1520 lm

⚡ 20W 220V

☼ CRI >90

📈 PF 0.9

🌒 Dim

📐 20° / 27° / 36°

🌡️ 2700K / 3000K / 4000K

● Acabado: negro/blanco

CINOR 20W

ESPECIFICACIONES TÉCNICAS

| Código | CT | Dim. | Sist. dim | Áng. | CRI | lm | lm/W | W | V | IP |
|--------|-------|------|-----------|-------------|-----|------|------|----|-----|----|
| TL55 | 2700K | Sí | TRIAC | 20°/27°/36° | >90 | 1445 | 70 | 20 | 220 | 20 |
| TL55 | 3000K | Sí | TRIAC | 20°/27°/36° | >90 | 1520 | 75 | 20 | 220 | 20 |
| TL55 | 4000K | Sí | TRIAC | 20°/27°/36° | >90 | 1595 | 80 | 20 | 220 | 20 |

MacAdam <5

DISTRIBUCIÓN DE INTESIDAD LUMÍNICA

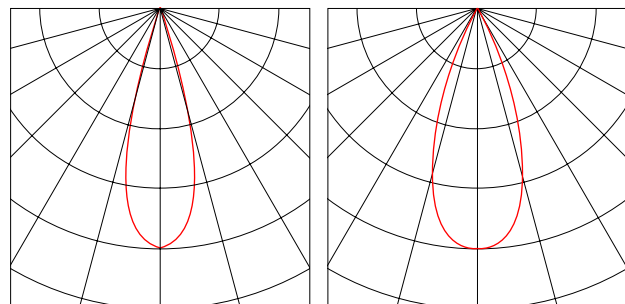

$I_{max}=9150$ cd
 α C0-C180 =20°

$I_{max}=7425$ cd
 α C0-C180 =27°

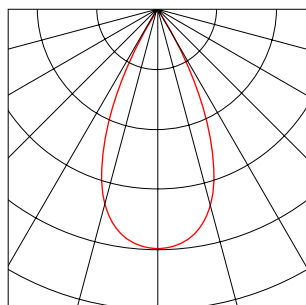

Parámetros
de fotometría en 3000K

$I_{max}=4297$ cd
 α C0-C180 =36°

PROYECCIÓN DE LUZ A DISTANCIA

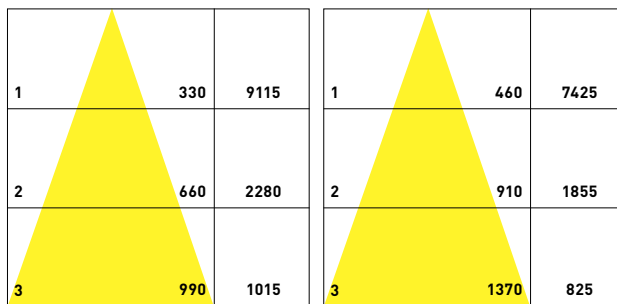

M (Altura) 20° (Diámetro) lx

M (Altura) 27° (Diámetro) lx

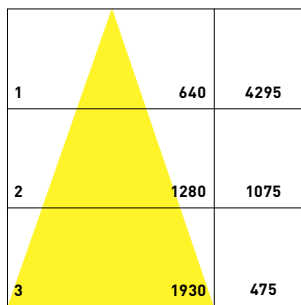

M (Altura) 36° (Diámetro) lx

DIMENSIONES SPOT 20W

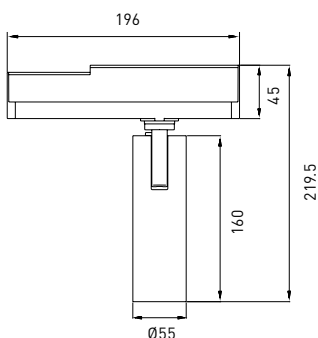

Driver y adaptador incluidos.
Opción driver DALI disponible.



CINOR 20W

RIELES COMPATIBLES

Riel 3 efectos marca Artelum modelos: 53411, 53412 y 53413

Riel 3 efectos marca Starnova modelos "Euro"

ACCESORIOS OPCIONALES

| Código | Descripción |
|-------------|---|
| TL-20W-DPOT | Driver lineal para armado de Cinor en perfil de 20W. Válido para 2 Cinor 11W o 1 Cinor 20W. |
| TL-30W-DPOT | Driver lineal para armado de Cinor en perfil de 30W. Compatible únicamente con Cinor 27W. |

CONFIGURABLE

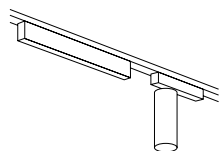

Los artefactos de la línea Cinor son configurables con perfiles Linear, Linear Slim y Slim Box.

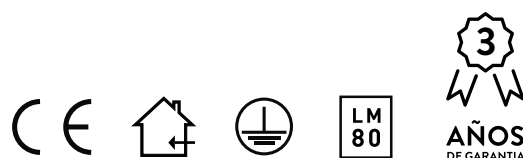



AÑOS
DE GARANTÍA

LM
80



CINOR 27W

Tracklight con driver dimerizable para embutir en riel.
Cuerpo de aluminio. Antideslumbrante color negro incluido

💡 2465 lm

⚡ 27W 220V

☼ CRI >90

📈 PF 0.9

📶 Dim

📐 20° / 27° / 36°

🌡️ 2700K / 3000K / 4000K

🎨 Acabado: negro/blanco

CINOR 27W

ESPECIFICACIONES TÉCNICAS

| Código | CT | Dim. | Sist. dim | Áng. | CRI | lm | lm/W | W | V | IP |
|--------|-------|------|-----------|-------------|-----|------|------|----|-----|----|
| TL65 | 2700K | Sí | TRIAC | 20°/27°/36° | >90 | 2230 | 80 | 27 | 220 | 20 |
| TL65 | 3000K | Sí | TRIAC | 20°/27°/36° | >90 | 2350 | 85 | 27 | 220 | 20 |
| TL65 | 4000K | Sí | TRIAC | 20°/27°/36° | >90 | 2465 | 90 | 27 | 220 | 20 |

MacAdam <5

DISTRIBUCIÓN DE INTESIDAD LUMÍNICA

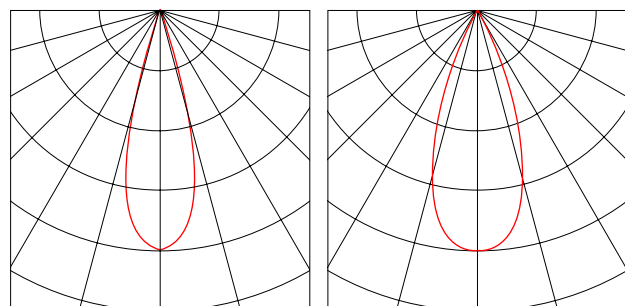

$I_{max}=12375$ cd
 α C0-C180 =20°

$I_{max}=1090$ cd
 α C0-C180 =27°

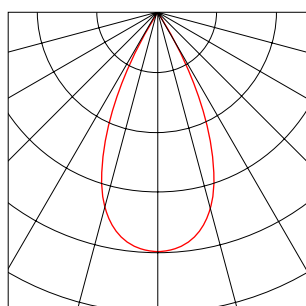

Parámetros
de fotometría en 3000K

$I_{max}=6076$ cd
 α C0-C180 =36°

PROYECCIÓN DE LUZ A DISTANCIA

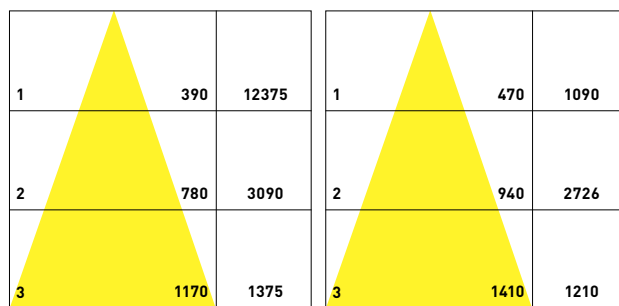

M (Altura) 20° mm (Diámetro) lx

M (Altura) 27° mm (Diámetro) lx

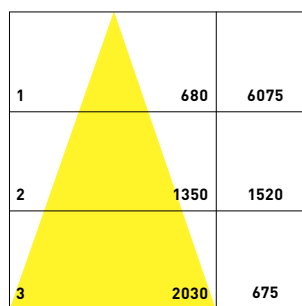

M (Altura) 36° mm (Diámetro) lx

DIMENSIONES SPOT 27W

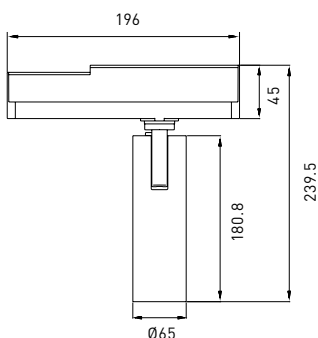

Driver y adaptador incluidos.
Opción driver DALI disponible.

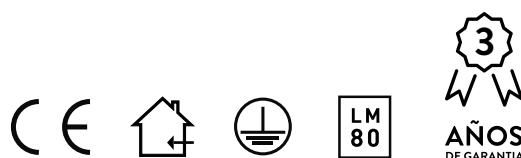

CINOR 27W

RIELES COMPATIBLES

Riel 3 efectos marca Artelum modelos: 53411, 53412 y 53413

Riel 3 efectos marca Starnova modelos "Euro"

ACCESORIOS OPCIONALES

| Código | Descripción |
|-------------|---|
| TL-20W-DPOT | Driver lineal para armado de Cinor en perfil de 20W. Válido para 2 Cinor 11W o 1 Cinor 20W. |
| TL-30W-DPOT | Driver lineal para armado de Cinor en perfil de 30W. Compatible únicamente con Cinor 27W. |

CONFIGURABLE

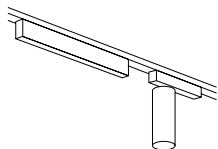

Los artefactos de la línea Cinor son configurables con perfiles Linear, Linear Slim y Slim Box.

